

POP-UP ASSEMBLY INSTRUCTIONS

1

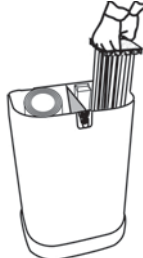

A typical kit includes frame, magnetic bars, 2x D-end graphics and front facing graphics.

2

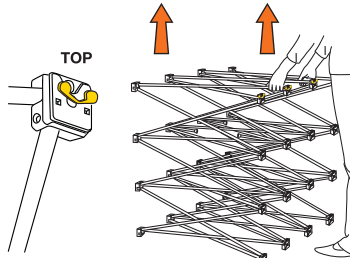

Assemble frame with the yellow coloured hookstuds at the top.

3

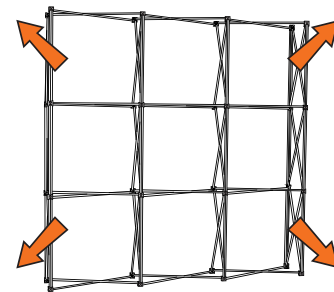

Open out framework.

4

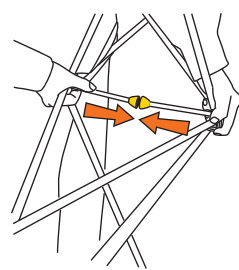

Push the locking bars together until they attach magnetically.

5

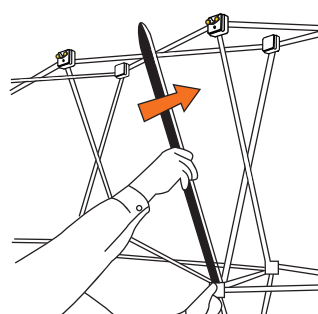

Attach magnetic bars to frame.

6

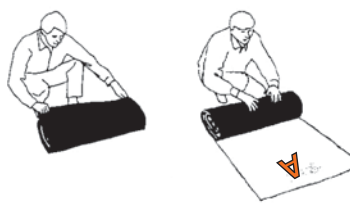

Unroll the graphic panels which are labeled on the rear.

7

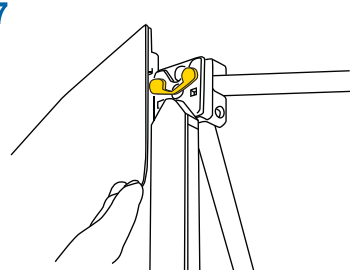

Hook on reverse of panel locates on the yellow coloured stud.

8

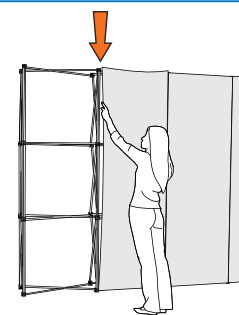

Align panel edges down centre of magnetic bar.

9



D-end panels curve from front to back.

10 Fitting lighting to frame

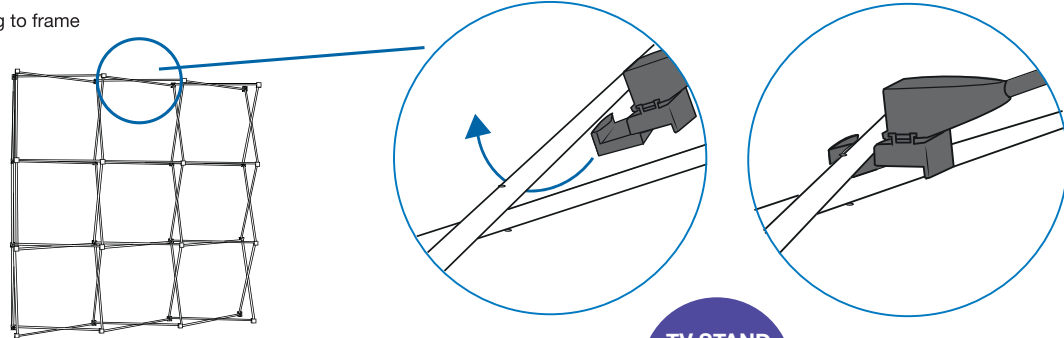

TV STAND ASSEMBLY INSTRUCTIONS (3-PART POLE)
TV Size from 32" to 60"

1

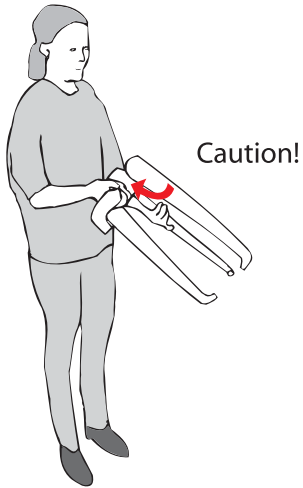

2

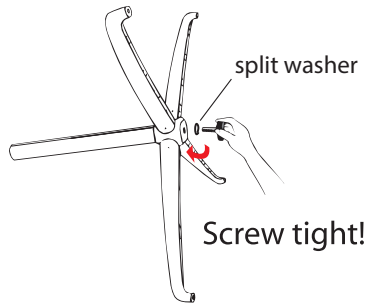

3

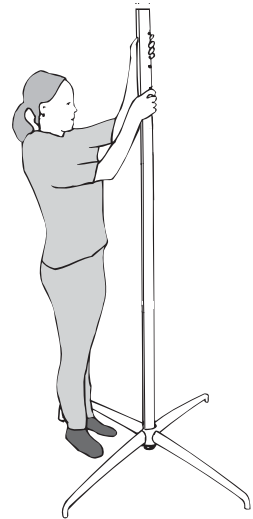

4

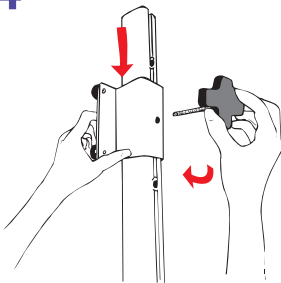

5

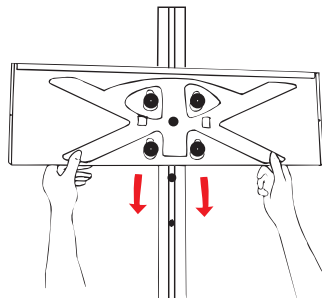

6

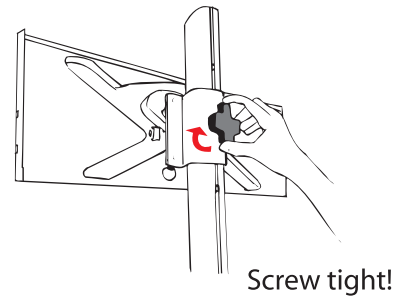

7

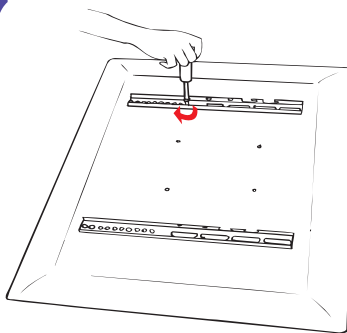

8

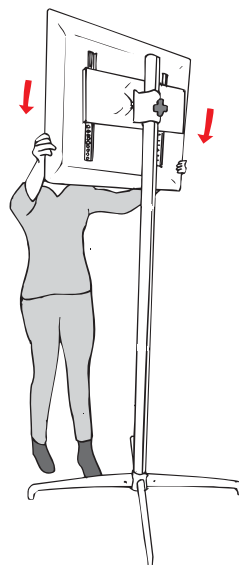

TV STAND ASSEMBLY INSTRUCTIONS

Inserting Lock Pin

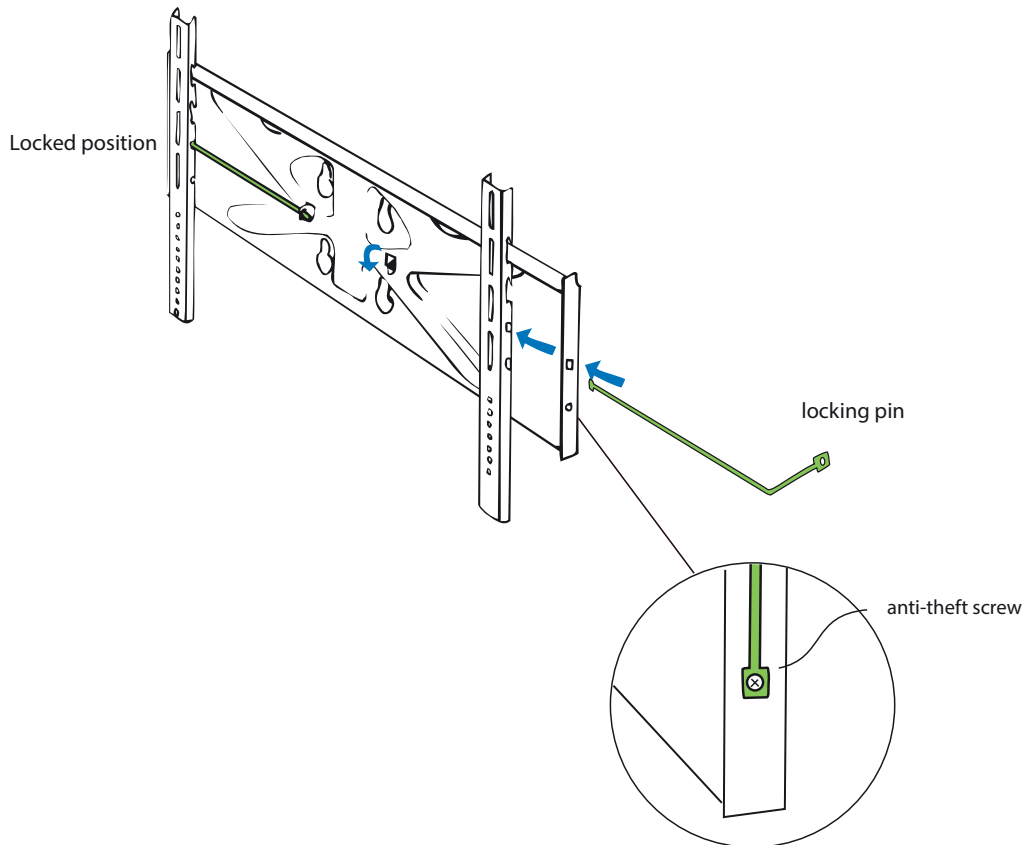

M8/20 M6/20 M6/12 M5/20 M5/12 M4/20 M4/12

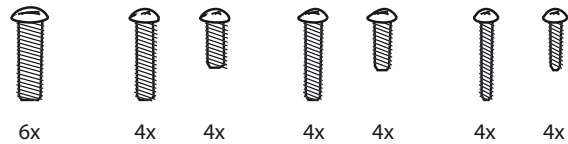

TV STAND ASSEMBLY INSTRUCTIONS

